

RECOMMENDED PRACTICE FOR NUMBERING CULVERTS, BRIDGES AND TUNNELS

(Second Revision)

Published by:

INDIAN ROADS CONGRESS

Kama Koti Marg,
Sector-6, R.K. Puram,
New Delhi-110 022

NOVEMBER 2017

Price : ₹ 100/-
(Plus Packing & Postage)

CONTENTS

S. No.	Description	Page No.
	Personnel of the Bridges Specifications and Standards Committee	i
1.	Introduction	2
2.	Scope	2
3.	Numbering of Structures	2
4.	Salient Information	3
5.	Inscription of Structure Number	3
6.	Information Plate	4
7.	Numerals and details	4
8.	Maintenance	4

1 INTRODUCTION

A uniform system of numbering of all the structures is essential for proper asset management. All culverts, minor bridges, major bridges, underpasses, flyovers, grade separators and tunnels on road shall be assigned separate numbers. This is a means for their easy identification of location and type of structure for the personnel for inspection and maintenance.

2 SCOPE

2.1 This document covers structures on all roads in the country.

2.2 Structures shall include

- i) All culverts, including slab, box, hume pipes etc.
- ii) All bridges
- iii) All underpasses
- iv) All overpasses, pedestrian bridges etc.
- v) ROB's, flyovers and grade separator etc.
- vi) Tunnels
- vii) Any other structure

3 NUMBERING OF STRUCTURES

3.1 All structures on a road shall be numbered in serial order, in each kilometer separately.

3.2 The number shall be in the form of a fraction, the numerator denoting the number of kilometer in which the structure is situated and the denominator the km wise serial number of the structure. For instance, the 5th structure in the 4th km (i.e. between km stones 3 and 4) shall be designated as 4/5, and the 8th structure in 25th km as 25/8.

3.3 For multi-lane carriageways, there should be either one combined structure or separate bridge structures. In case of one combined structure, the structure number shall be designated as in Sub-Clause 3.2 above. In case of separate bridge structures, the structure number shall be indicated as mentioned hereinafter. As the section progresses, the left hand side structure will have a suffix 'L' and the right hand side structure will have a suffix 'R'. Similarly, the structures on service roads will have additional suffix 'S'. For example:

Location of structures		Structure no.
2 nd structure between km 280 and 281		
i.	Left side structure on service road	281/2 LS
ii.	Right side structure on service road	281/2 RS
iii.	Left side structure on main carriageway	281/2 L
iv.	Right side structure on main carriageway	281/2 R

3.4 If any new culvert bridge or structures are built subsequently, say between the 3rd. and 4th structure in km 375, the same shall be designated as 375/3/1, 375/3/2, etc.

4 SALIENT INFORMATION

For inspection and maintenance, it is useful to have mention of following salient information about structures:

- a) Year of construction
- b) Name of Channel / River / Crossing
- c) Length
- d) Span arrangement
- e) HFL
- f) Deck Level*¹
- g) Roadway
- h) Type of structure [e.g. RCC/PSC, T-Beam and slab, Box girder, RCC/Stone Slab, Box culvert, tunnel feature, Arch, HP, Steel, Cable stayed, Extra-dosed].

These shall be provided on separate plate on the right hand side of the carriageway or the road.

5 INSCRIPTION OF STRUCTURE NUMBER

5.1 The structure number shall be inscribed near the top left hand side parapet wall railing posts for end of crash barrier as seen by traffic in the end elevation when approaching the structure from each direction. These are illustrated in **Figs.1, 2 and 3**.

5.2 In situations where instead of parapet walls, the structure is provided with railings, but having no end supporting pillars on which the number etc. could be inscribed, the number of the structure shall be indicated by means of a separate numbering plate of the size 300 mm x 300 mm. There shall be two such numbering plates, one for each direction. The plates shall be welded or fixed securely on the left hand side facing the carriageway as close to entrance to the structure as possible.

5.3 In case of structures, such as pipe culverts, where there are usually no parapet walls or railings at the roadway level, two stone or R.C.C. marker posts, having a cross section of 150 mm x 150 mm and exposed height of at least 300 mm, shall be set up on the left side, one in each direction. Care shall be taken to locate the marker posts fully outside

*1 Deck Level shall indicate the level of bridge deck at the starting point of bridge as the section progresses, as under:

- i) For 2-lane bridge – Deck Level at the road kerb (right side)
- ii) For multi-lane carriageway – Deck Level at median

the prescribed roadway width. The culvert number shall be either engraved or painted. Alternatively, the number might also be inscribed at a suitable location on the head wall of the structure above the highest flood level.

6 INFORMATION PLATE

6.1 The information of the structure shall be inscribed on two information plates one in each direction and fixed in the end elevation on a plate size near the top right hand side parapet wall / railing parts or end post of crash barrier etc. in the end elevation when approaching the structure. Information plate shall be of size 300 mm x 500 mm (for minor bridge and culverts) and 500 mm X 1000 m (for major bridges and other structures) Illustration is given in **Fig. 4**. The plate shall be fixed near the top right hand side.

6.2 In situation where instead of parapet walls, the structure is provided with railings, but having no end supporting pillars on which information could be inscribed, the same shall be indicated on a separate information plate of size 300 x 500 m. There shall be two such information plates, one in each direction. The plates shall be welded or fixed securely on the right hand side facing the carriageway as close to the entrance to the structure as possible.

6.3 In case of structures, such as pipe culverts where there are usually no parapet walls or railings, at the roadway level, two stone or R.C.C. posts having a cross section of 150 x 150 mm and exposed height of at least 500 mm, shall be set up on right side, one in each direction, on which an information plate of size 300 x 500 mm shall be fixed or welded securely. Care shall be taken to locate the posts and the plates fully outside the prescribed roadway width.

7 NUMERALS AND DETAILS

7.1 The numerals used shall be 100 mm high and of international form conforming to IRC: 30-1968 Standard Letters and Numerals of Different Height for use on Highway Signs. These shall be painted on smooth panels as prescribed. In case of right hand panel the height shall be suitably adjusted so that it does not obstruct the visibility. The colour of the background shall be canary yellow, ISI Shade 309.

8 MAINTENANCE

8.1 The structure numbers and information plate shall be updated whenever any change takes place affecting the existing position. They shall be kept clean well maintained and regularly painted.

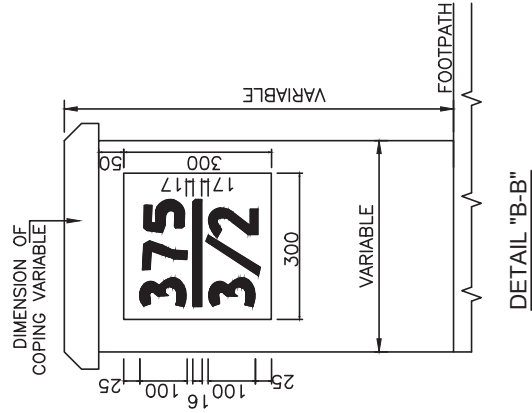
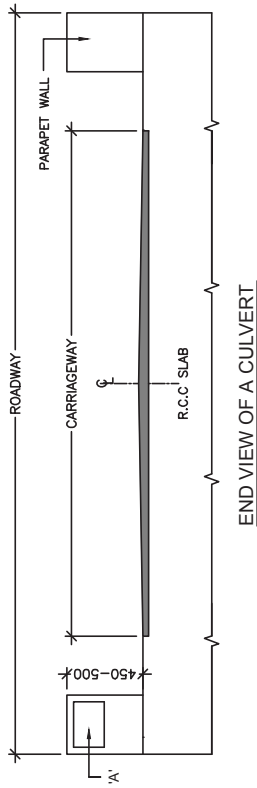
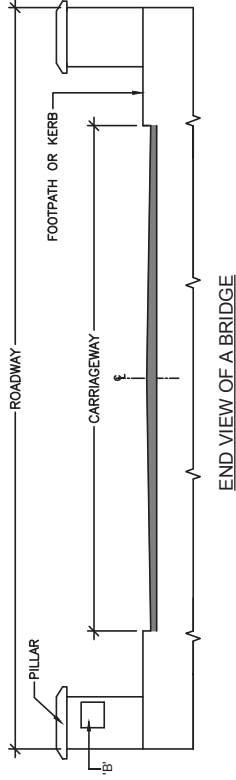

NOTES:-
1. ALL DIMENSIONS ARE IN MM.

Fig. 2 Structure Number

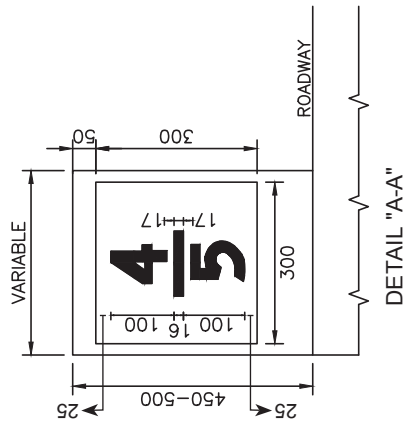

NOTES:-
1. ALL DIMENSIONS ARE IN MM.

Fig. 1 Structure Number

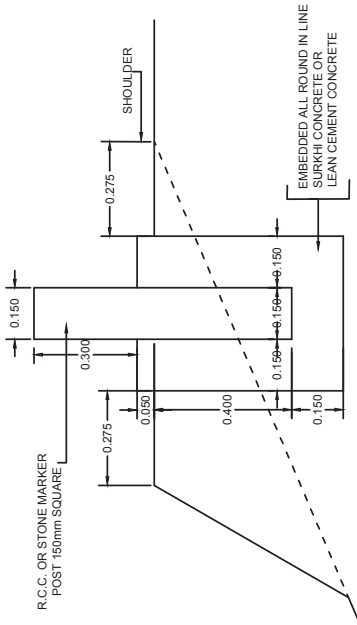

DETAILS AT-C

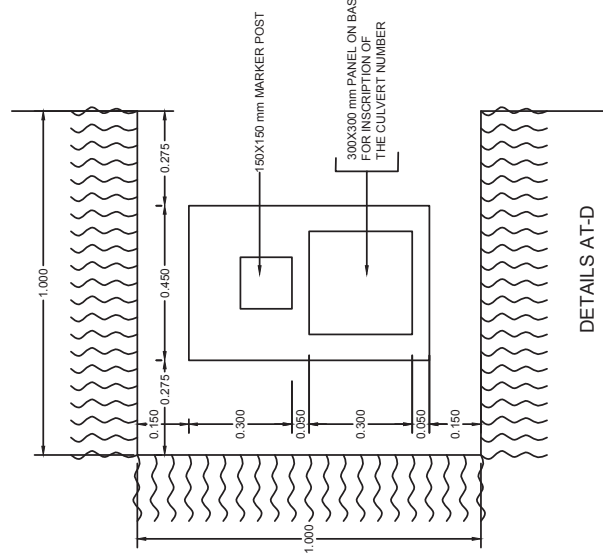

DETAILS AT-D

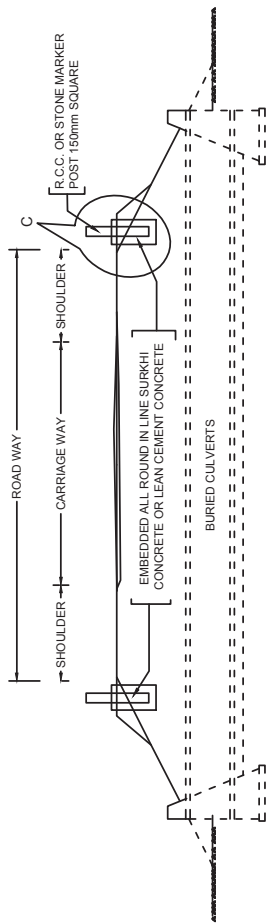

SECTION AT -1 1

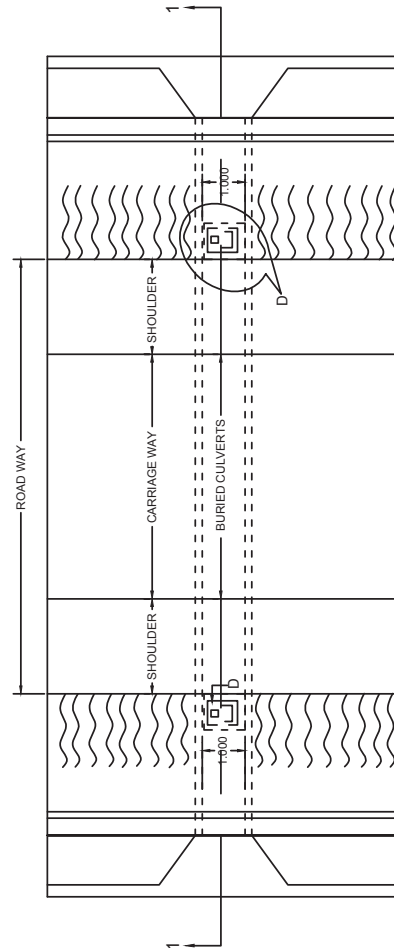

PLAN

Fig. 3 Structure number for Pipe Culverts and other Structures without end Pillars

ALL DIMENSION IN mm

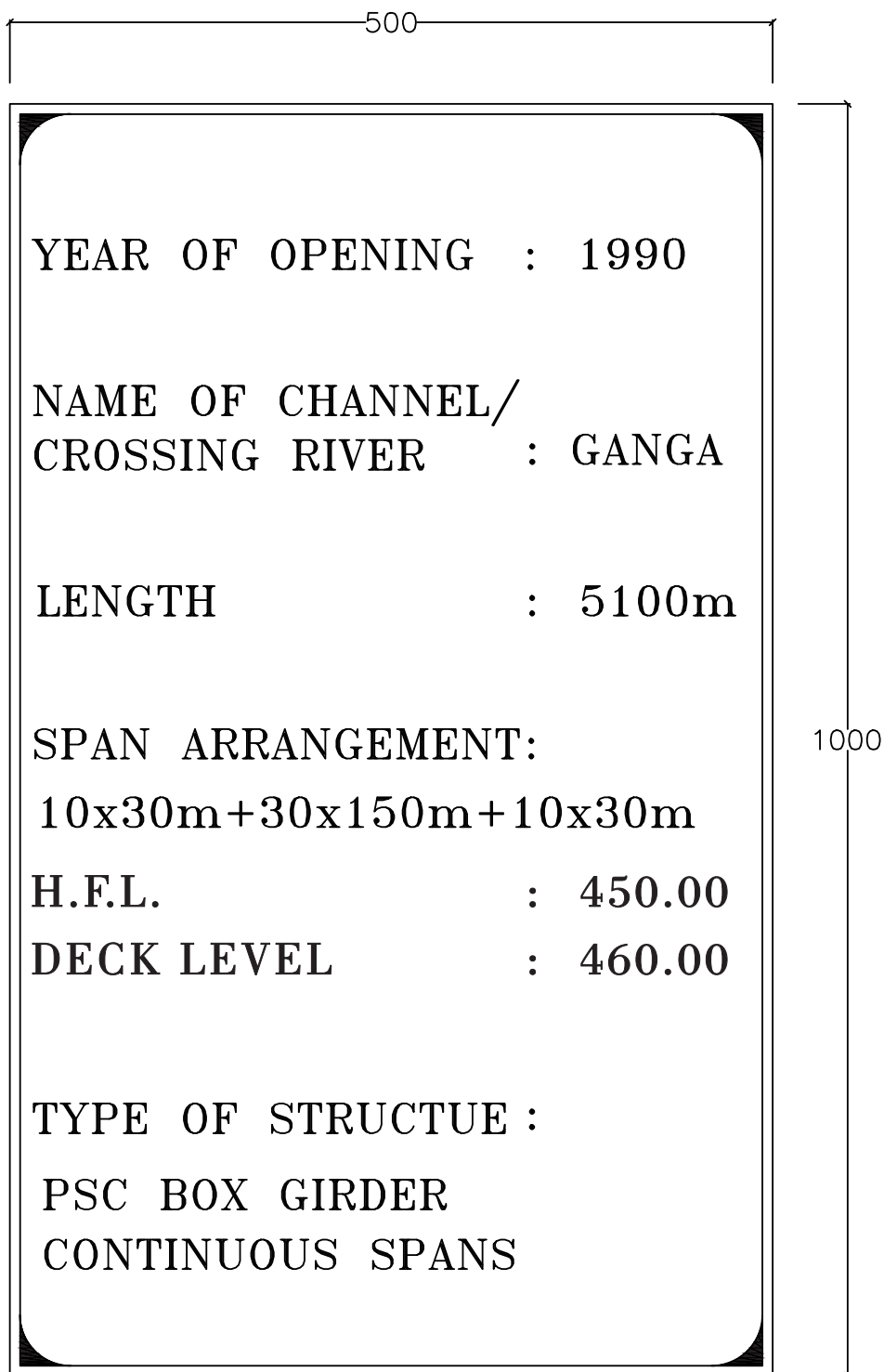

500

YEAR OF OPENING : 1990

NAME OF CHANNEL/
CROSSING RIVER : GANGA

LENGTH : 5100m

SPAN ARRANGEMENT:
10x30m+30x150m+10x30m

H.F.L. : 450.00

DECK LEVEL : 460.00

TYPE OF STRUCTUE :
PSC BOX GIRDER
CONTINUOUS SPANS

1000

Fig. 4 Information Plate for Major Bridges and other Structures